



COURSE OVERVIEW EE0625
Certified High Voltage Electrical Safety
(IEC, OSHA, NFPA & EN Standards)

Course Title

Certified High Voltage Electrical Safety (IEC, OSHA, NFPA & EN Standards)

Course Date/Venue

August 04- 08, 2025/Ajman Meeting Room, Grand Millennium Al Wahda Hotel, Abu Dhabi, UAE

Course Reference

EE0625

Course Duration/Credits

Five days/3.0 CEUs/30 PDHs

Course Description



This practical and highly-interactive course includes various practical sessions and exercises. Theory learnt will be applied using our state-of-the-art simulators.

High voltage electrical systems require the special application of maintenance, repair, test, and safety procedures. Personnel must be trained in special precautions to ensure both personnel and workplace safety. OSHA requires training for all qualified employees performing operations or maintenance work, or who have access to electrical power generation, transmission and distribution installations as well as HSE personnel who are in charge of the safety and health of the employees, public and facilities.



This course covers the knowledge and skills needed to safely work with energized high-voltage high-energy electric power systems. Principles and procedures for the safe operation and maintenance of high voltage systems are covered. Insulated hand tools, "hot-sticks", proper grounding procedures, proper protective clothing, and thorough job-planning procedures are stressed throughout the course.



Properties of electric charge, energy, electric potential, dielectric stress, capacitive and inductive coupling, and material behavior in electromagnetic fields are covered. The effects of electrical energy on humans and various protection concepts are addressed, as are basic first aid practices.



Differential protection schemes, insulation materials, Faraday cages, equi-potential grounding, live-line tools, and isolation techniques are covered from both the technical and practical perspectives.

Various OSHA, IEEE, IEC, European and NFPA safety procedures are reviewed. In this interactive course, group exercises include the development of safe-work protocols, use of lockout/tagout (LOTO), maintenance task rehearsal, and equipment preparation. Calculations of fault current, arc-flash hazards, and proper PPE selection are studied. Other technical topics covered include insulation testing (IR/PI/DAR/DD), four-wire Kelvin low-resistance testing, corona detection by ultrasonic and RF detectors, and signature analysis using an infrared imager.

Successful course participants who attend the course and pass competency exam, will be certified to work on high voltage electrical power systems. Course participants are introduced to the hazards of electrical work and the philosophies of preventing accident and minimizing outage time due to improper safety or work practices. Also included as part of the curriculum are study materials participants may use at their own pace to continue their learning experience. This course addresses OSHA training requirements established in OSHA 29 CFR 1910.269.

Course Objectives

Upon the successful completion of this course, each participant will be able to:-

- Get certified on high voltage electrical safety in accordance with OSHA, NFPA, IEC, IEEE and EN standards
- Apply proper techniques and procedures on High Voltage (HV) electrical safety in accordance with the international standards OSHA, NFPA, IEEE and EN
- Explain the electrical safety standards and regulations including voltages
- Discuss basic electricity and HV installations
- Describe HV equipment including power transformers, switches, isolators and fuses, circuit breakers, instrument transformers, surge arrestors, capacitor banks as well as earth and shunt reactors
- Recognized the characteristics and applications of gas insulated substations (GIS) and review metal-enclosed and metal clad switchgears
- Analyze motor controllers, protection relays and carryout testing and commissioning
- Illustrate test equipment and discuss electrical switching as well as electrical and special hazards
- Apply hazardous area classification, classify hazardous materials, identify and control ignition sources, discuss HAC standards, identify and reduce/eliminate the risk and select electrical and equipment in hazardous areas
- Employ safety management and review de-energized and energized work
- Identify confined space as well as apply permit to work procedures and implementation
- Carryout personnel protection and emergency planning as well as identify portable cables



Exclusive Smart Training Kit - H-STK®



Participants of this course will receive the exclusive “Haward Smart Training Kit” (H-STK®). The H-STK® consists of a comprehensive set of technical content which includes **electronic version** of the course materials, sample video clips of the instructor’s actual lectures & practical sessions during the course conveniently saved in a **Tablet PC**.

Who Should Attend

This course is designed for electrical engineers, industrial & utility engineers, HSE personnel and other staff exposed to high voltages. Supervisors or managers concerned with the safety of electrical workers will find this course especially useful in providing an insight into electrical safety. Course participants are introduced to the hazards of electrical work and the philosophies of preventing accident and minimizing outage time due to improper safety or work practices. Also included as part of the curriculum are study materials participants may use at their own pace to continue their learning experience. This course addresses OSHA training requirements established in OSHA 29 CFR 1910.269 and other international standards.

Training Methodology

All our Courses are including **Hands-on Practical Sessions** using equipment, State-of-the-Art Simulators, Drawings, Case Studies, Videos and Exercises. The courses include the following training methodologies as a percentage of the total tuition hours:-

- 30% Lectures
- 20% Practical Workshops & Work Presentations
- 30% Hands-on Practical Exercises & Case Studies
- 20% Simulators (Hardware & Software) & Videos

In an unlikely event, the course instructor may modify the above training methodology before or during the course for technical reasons.

Course Fee

US\$ 5,500 per Delegate + **VAT**. This rate includes H-STK® (Haward Smart Training Kit), buffet lunch, coffee/tea on arrival, morning & afternoon of each day.



Course Certificate(s)

(1) Internationally recognized Competency Certificates and Plastic Wallet Cards will be issued to participants who completed a minimum of 80% of the total tuition hours and successfully passed the exam at the end of the course. Successful candidate will be certified to work on high voltage electrical power systems. Certificates are valid for 3 years.

Recertification is FOC for a Lifetime.

Sample of Certificates

The following are samples of the certificates that will be awarded to course participants:-

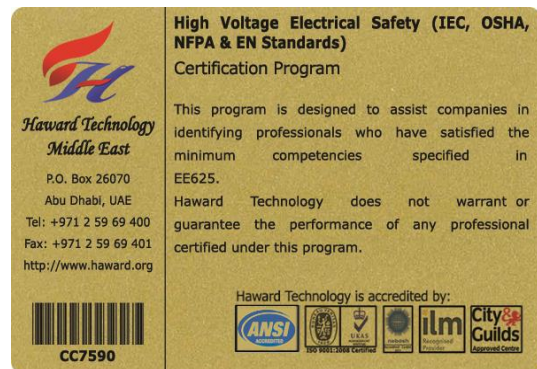
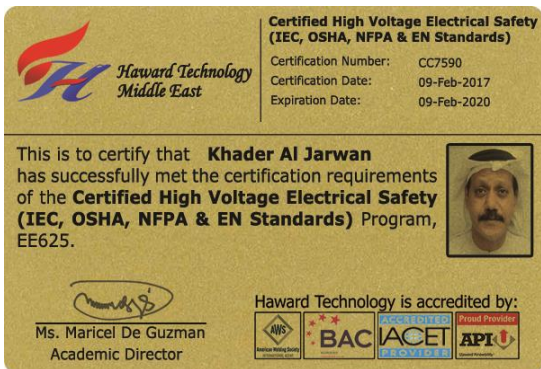
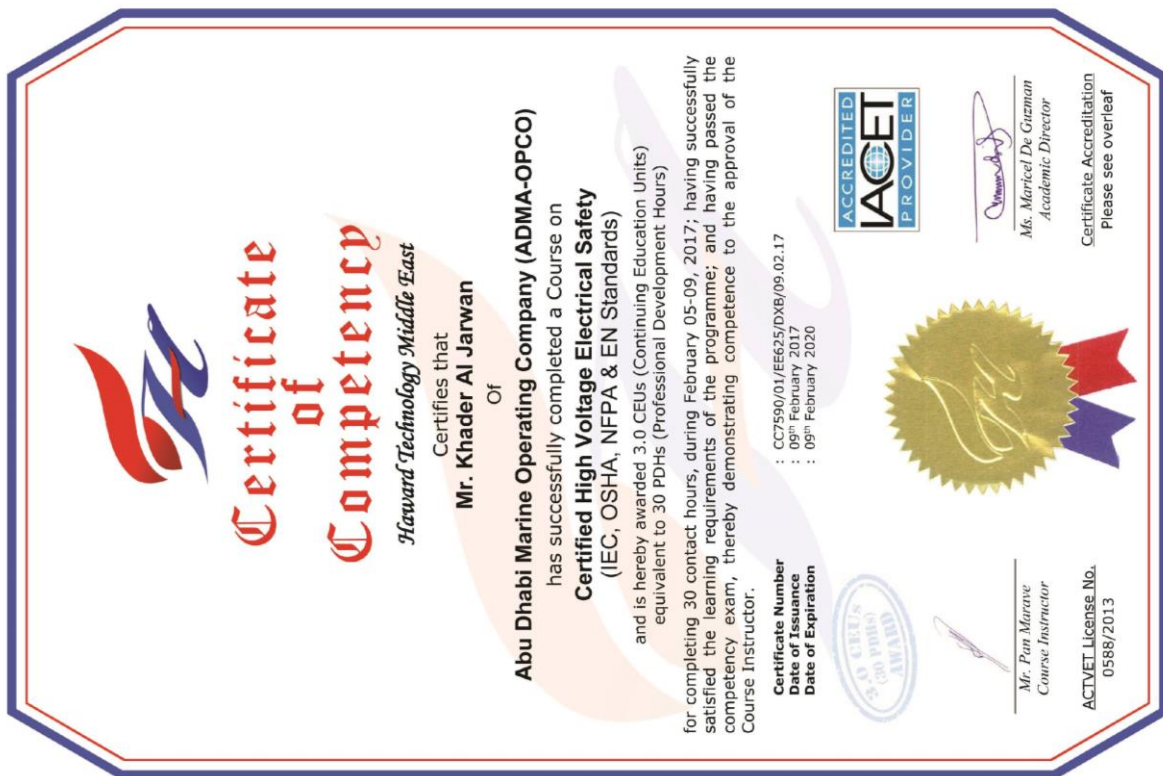

- (2) Official Transcript of Records will be provided to the successful delegates with the equivalent number of ANSI/IACET accredited Continuing Education Units (CEUs) earned during the course.

Page 1 of 1

CEUs



Haward Technology Middle East
Continuing Professional Development (HTME-CPD)

CEU Official Transcript of Records

TOR Issuance Date: 09-Feb-17
HTME No. PAR213886
Participant Name: Khader Al Jarwan

Program Ref.	Program Title	Program Date	No. of Contact Hours	CEU's
EE625	Certified High Voltage Electrical Safety (IEC, OSHA, NFPA & EN Standards)	February 05-09, 2017	30	3.0
Total No. of CEU's Earned as of TOR Issuance Date				3.0

TRUE COPY

 Maricel De Guzman
 Academic Director

Haward Technology has been approved as an Authorized Provider by the International Association for Continuing Education and Training (IACET), 1760 Old Meadow Road, Suite 500, McLean, VA 22102, USA. In obtaining this approval, Haward Technology has demonstrated that it complies with the ANSI/IACET 1-2013 Standard which is widely recognized as the standard of good practice internationally. As a result of their Authorized Provider membership status, Haward Technology is authorized to offer IACET CEUs for programs that qualify under the ANSI/IACET 1-2013 Standard.

Haward Technology's courses meet the professional certification and continuing education requirements for participants seeking Continuing Education Units (CEUs) in accordance with the rules & regulations of the International Association for Continuing Education & Training (IACET). IACET is an international authority that evaluates programs according to strict, research-based criteria and guidelines. The CEU is an internationally accepted uniform unit of measurement in qualified courses of continuing education.

Haward Technology is accredited by



P.O. Box 26070, Abu Dhabi, United Arab Emirates | Tel.: +971 2 3091 714 | Fax: +971 2 3091 716 | E-mail: info@haward.org | Website: www.haward.org

Certificate Accreditations

Certificates are accredited by the following international accreditation organizations: -

- 
The International Accreditors for Continuing Education and Training (IACET - USA)

Haward Technology is an Authorized Training Provider by the International Accreditors for Continuing Education and Training (IACET), 2201 Cooperative Way, Suite 600, Herndon, VA 20171, USA. In obtaining this authority, Haward Technology has demonstrated that it complies with the **ANSI/IACET 2018-1 Standard** which is widely recognized as the standard of good practice internationally. As a result of our Authorized Provider membership status, Haward Technology is authorized to offer IACET CEUs for its programs that qualify under the **ANSI/IACET 2018-1 Standard**.

Haward Technology's courses meet the professional certification and continuing education requirements for participants seeking **Continuing Education Units (CEUs)** in accordance with the rules & regulations of the International Accreditors for Continuing Education & Training (IACET). IACET is an international authority that evaluates programs according to strict, research-based criteria and guidelines. The CEU is an internationally accepted uniform unit of measurement in qualified courses of continuing education.

Haward Technology Middle East will award **3.0 CEUs** (Continuing Education Units) or **30 PDHs** (Professional Development Hours) for participants who completed the total tuition hours of this program. One CEU is equivalent to ten Professional Development Hours (PDHs) or ten contact hours of the participation in and completion of Haward Technology programs. A permanent record of a participant's involvement and awarding of CEU will be maintained by Haward Technology. Haward Technology will provide a copy of the participant's CEU and PDH Transcript of Records upon request.

- 
British Accreditation Council (BAC)

Haward Technology is accredited by the **British Accreditation Council** for **Independent Further and Higher Education** as an **International Centre**. BAC is the British accrediting body responsible for setting standards within independent further and higher education sector in the UK and overseas. As a BAC-accredited international centre, Haward Technology meets all of the international higher education criteria and standards set by BAC.

Accommodation

Accommodation is not included in the course fees. However, any accommodation required can be arranged at the time of booking.

Course Instructor(s)

This course will be conducted by the following instructor(s). However, we have the right to change the course instructor(s) prior to the course date and inform participants accordingly:



Mr. Ahmed Hayajneh (Ahmed Abdel-Aziz Mohammed Hayajneh) is a **Senior Electrical Engineer** with over **20 years** of experience in **Oil, Gas, Petrochemical, Refinery & Power** industries. His expertise widely covers in the areas of **Power System Equipment, Power Systems & Auxiliary Power Systems, Power Cable Standard and Testing, Cables & Wiring, Overhead Transmission Lines, Transmission Network Maintenance, Electrical Forecasting Techniques, Inspection Reporting Techniques, Electrical Substation Design & Planning, Electrical Drawings & Schematics, Fault Detection Analysis, Distribution Networks & Load Forecasting, Power Generation, Electrical Power System, Electrical Installations & Utilities, Electrical Distribution Systems & Control Circuits, Electrical Drawings, Relay Logic Circuits, Troubleshooting Transformers, System Grounding, Circuit Breakers, Protection Devices & Technology, Protection Relay, Transformers, Generators, Power Transformers, Motors, Substations, Switchgears & Distribution, Power System Analysis, Power Quality Studies & Load Criteria, Power Supply Substations, Electrical Equipment Control Systems, Transformer Maintenance & Testing, HV/MV Cable Splicing, Jointing, Inspection & Termination, HV/LV Equipment, High Voltage Electrical Safety, LV & HV Electrical System, HV Equipment Inspection & Maintenance, HV Switchgear Operation & Maintenance, LV Distribution Switchgear & Equipment, LV/MV Electrical Safety (11 KV, 415 & 220 Voltage), Electrical Substation & Design, Substation Earthing System, Electrical Equipment Maintenance, Electrical Safety, Electrical Protection, Batteries, Chargers & UPS, Electrical Submersible Pumps (ESP), Area Classification, Safety Management System, Permit to Work & Issuing Authority, Emergency Diesel Generator, Variable Frequency Drives (VFD), PLC & SCADA for Automation & Process Control, Automation Solutions & Techniques, Automating Process Equipment, DCS Automated Process Control Systems, High & Low Voltage Electrical Safety, Electrical Inspection & Testing, Electrical Control & Monitoring System, Electric Power System, Intensive Overhead Transmission Line (OHTL), Generator Maintenance & Troubleshooting, Transmission Line Networks, Distribution Engineering, HVDC Transmission & Control, Substation Maintenance Techniques and Overhead Power Line Construction & Patrolling.**

Mr. Ahmed gained his expertise and experience through several positions as a **Construction Manager, Site Manager, Senior Electrical Project Engineer, Senior Electrical Engineer, Site Electrical Engineer, Operations Engineer, Field/Site Engineer** and **Senior Instructor/Trainer** for various companies such as United Electro-Mechanical International Company, AL OSAIS Contracting Co., ASTRACO, Saudi Service for Electro Mechanic Work Co. (S.S.E.M), Arabian Oil & Gas, Dubai Electricity & Water Authority (DEWA) and Saudi Electricity Company (SEC).

Mr. Ahmed has a **Bachelor's** degree in **Electrical Engineering**. Further, he is a **Certified Instructor/Trainer**, a **Certified Internal Verifier/Assessor/Trainer** by the **Institute of Leadership and Management (ILM)** and has delivered various trainings, seminars, conferences, workshops and courses globally.

Course Program

The following program is planned for this course. However, the course instructor(s) may modify this program before or during the course for technical reasons with no prior notice to participants. Nevertheless, the course objectives will always be met:

Day 1: Monday, 04th August 2025

0730 – 0800	Registration & Coffee
0800 – 0815	Welcome & Introduction
0815 – 0830	PRE-TEST
0830 – 1045	Standards & Regulations IEC • OSHA • NFPA • IEEE • EN
1045 – 1145	Standard Voltage LV • MV • HV • EHV • UHV
1145 – 1200	Break
1200 – 1230	Basic Electricity Direct Current
1230 – 1300	Basic Electricity (cont'd) Alternating Current
1300 – 1315	Break
1315 – 1420	Basic of HV Installations
1420 – 1430	Recap
1430	Lunch & End of Day One

Day 2: Tuesday, 05th August 2025

0730 – 0930	HV Equipment – Power Transformers Types • Connections • Hazards & Testing • Troubleshooting • High Pot Testing • Step Regulators
0930 – 0945	Break
0945 – 1045	HV Equipment – Switches, Isolators & Fuses Characteristics and Functions • Types & Ratings • Testing & Hazards
1045 – 1145	HV Equipment – Circuit Breakers Characteristics and Functions • Types & Ratings • Testing & Hazards
1145 – 1230	HV Equipment – Instrument Transformers Characteristics and Functions • Types & Ratings • Connections • Grounding • Testing
1230 – 1245	Break
1245 – 1330	HV Equipment – Surge Arrestors Characteristics and Functions • Types & Ratings • Testing & Hazards
1330 – 1420	HV Equipment – Capacitor Banks Theory of Operation • Application & Hazards
1420 – 1430	Recap Using this Course Overview, the Instructor(s) will Brief Participants about the Topics that were Discussed Today and Advise Them of the Topics to be Discussed Tomorrow
1430	Lunch & End of Day Two

Day 3: Wednesday, 06th August 2025

0730 – 0830	HV Equipment – Earth & Shunt Reactors Characteristics and Functions • Types
0830 – 0900	Gas Insulated Substations (GIS) Characteristics • Applications
0900 – 0930	Metal-Enclosed & Metal Clad Switchgears Characteristics • Cubicles and Equipments



0930 – 0945	Break
0945 – 1045	Motor Controllers
1045 – 1145	Protection Relays
1145 – 1230	Testing & Commissioning
1230 – 1300	Test Equipment Ammeters, Ohmmeters, Voltmeters • Phase Angle Meters • Phasing Sticks/Devices • Oscilloscopes • Voltage Testers-Wiggy, etc. • Thumpers • Relay & Meter Test Equipment • Insulation Testers
1300 – 1315	Break
1315 – 1420	Electrical Switching Switching Programmes • Loads • Transformers • Capacitors • Switches and Isolators
1420 – 1430	Recap Using this Course Overview, the Instructor(s) will Brief Participants about the Topics that were Discussed Today and Advise Them of the Topics to be Discussed Tomorrow
1430	Lunch & End of Day Three

Day 4: Thursday, 07th August 2025

0730 – 0830	Electrical Hazards Electrical Shock and Effects • Electrical Arc • Safety Distances • Arc Blast • Accident Discussions
0830 – 0930	Special Hazards Unique Designs • Special Operating Requirements
0930 – 0945	Break
0945 – 1100	Hazardous Area Classification (HAC) Defining Hazardous Areas (Zoning) • Why Area Classification? • Classifying Hazardous Materials • Ignition Sources – Identification and Control • Hazardous Area Classification (HAC) Standards • Identify & Reduce/Eliminate the Risk • Selection of Electrical Equipment in Hazardous Areas
1100 – 1215	Safety Management Quality Management System • Work Health and Safety System • Forms and Records • Audits • Policies • Costs
1215 – 1230	Break
1230 – 1420	De-Energized Work Policies and Procedures • Voltage Detection Equipment • Lock and Tag Out • Permit to Work (PTW) • Grounds Grounds/Grounding • Personal Protective Grounds
1420 – 1430	Recap Using this Course Overview, the Instructor(s) will Brief Participants about the Topics that were Discussed Today and Advise Them of the Topics to be Discussed Tomorrow
1430	Lunch & End of Day Four

Day 5 Friday, 08th August 2025

0730 – 0830	Energized Work Policies and Procedures • Recognition • Work Zones (Controlled Areas) • Work Clearances • Planning A Job • Proper Tools
0830 – 0900	Confined Space Scope and Application • Training Requirements • Duties of Employers and Employees
0900 – 0930	Permit to Work (PTW) Procedure & Implementation Guidance Notes on Permit to Work (Site Specific if Requested) • Legal Responsibilities • Permit to Work (PTW) Key Players • Relationship between those Issuing Permits and those Working under PTW • When Should a Permit be Used • Who Issues Them • PTW Documentation • PTW Implementation





0930 – 0945	Break
0945 – 1045	Personnel Protection Personal Protective Equipment (PPE) • Rubber Gloves/Blanket • Flash Suits • Eye Protection • Hard Hats • Explosion Protection
1045 – 1145	Emergency Planning Communications • Electrical Fires and Fire Fighting • Phone Numbers • Panic Button • Tools/Equipment
1145 – 1200	Break
1200 – 1300	Portable Cables Application • Hazards
1300 – 1315	Course Conclusion Using this Course Overview, the Instructor(s) will Brief Participants about the Course Topics that were Covered During the Course
1315 – 1415	COMPETENCY EXAM
1415 – 1430	Presentation of Course Certificates
1430	Lunch & End of Course



Simulators (Hands-on Practical Sessions)

Practical sessions will be organized during the course for delegates to practice the theory learnt. Delegates will be provided with an opportunity to carryout various exercises using our state-of-the-art simulators “Haward Troubleshooting”, “Power World”, “GE Multilin Relay 469” and “GE Multilin Relay 750”.

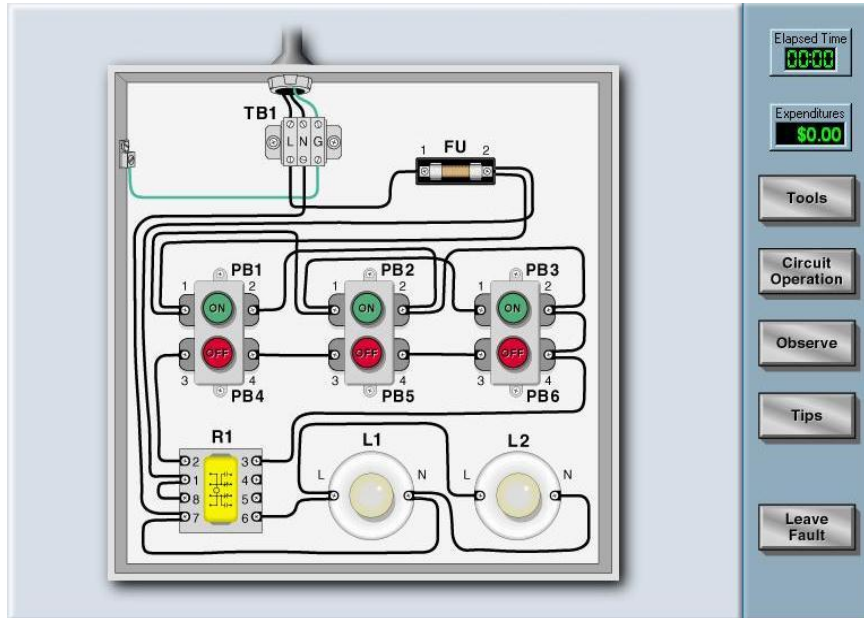

Basic Techniques

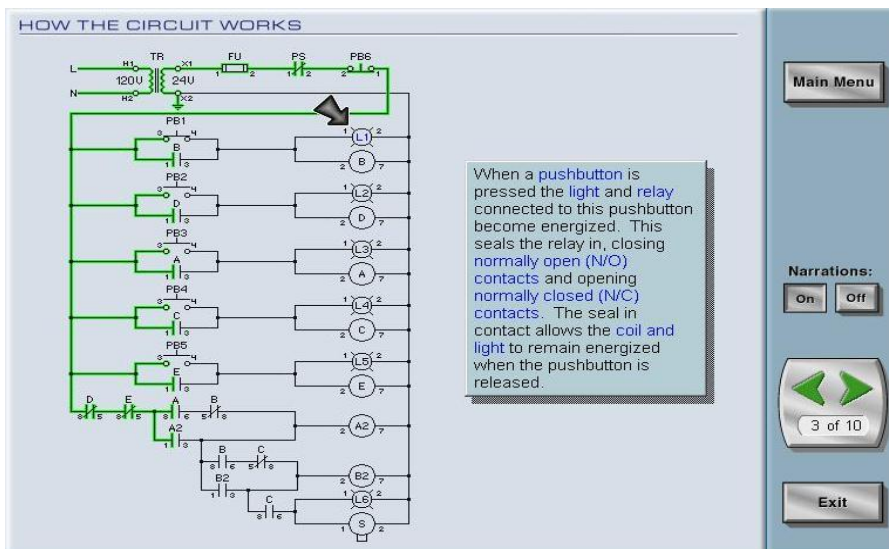

Basic Control Circuits

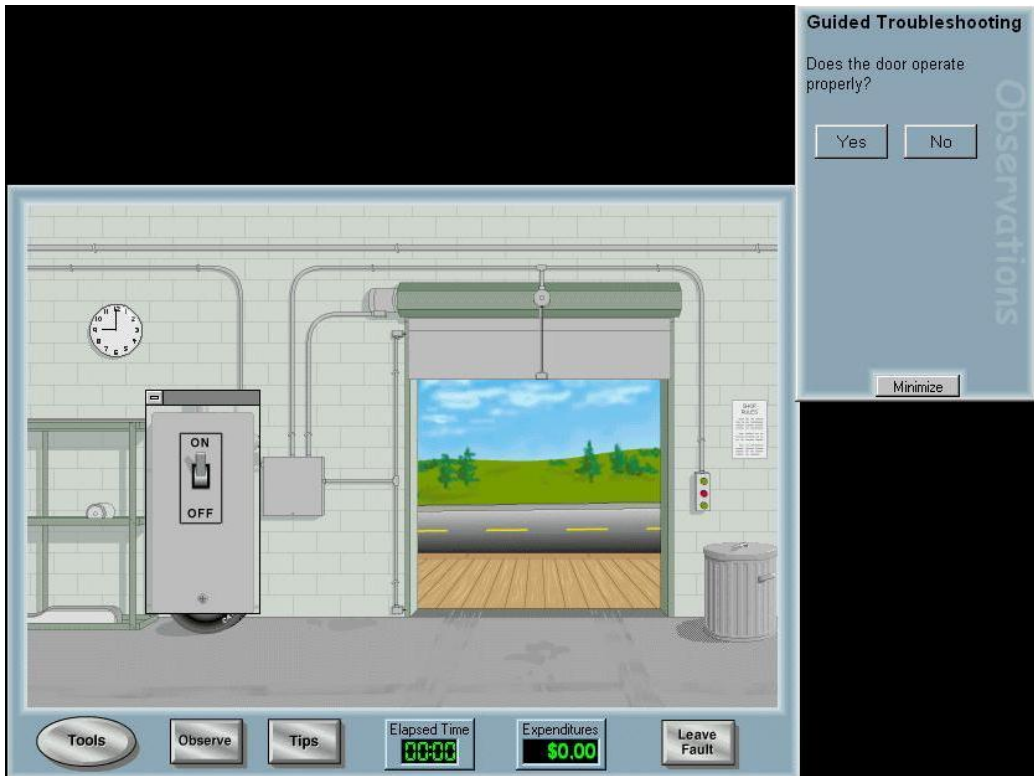

Motor Control Techniques

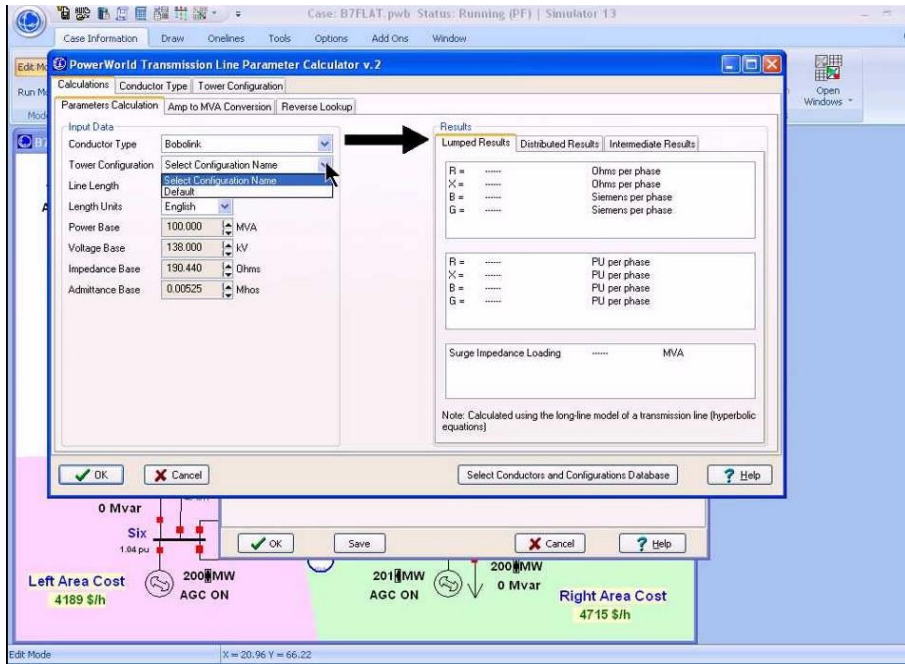

Power World Simulator





GE Multilin Relay 469 Simulator



GE Multilin Relay 750 Simulator

Course Coordinator

Mari Nakintu, Tel: +971 2 30 91 714, Email: mari1@haward.org